

# Data Sheet



Article number: 58MI25S0020CAG

Description: Cylinder MI-25x20-S-CA-G, Ø25x20  
Double acting type - port 1/8"

## Measures

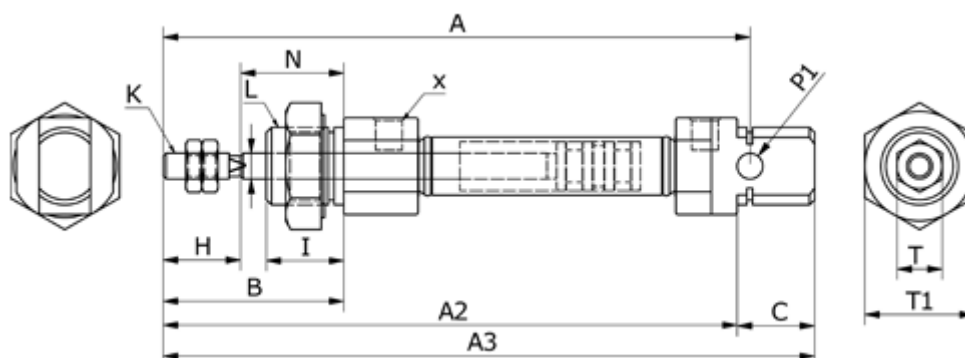

A	= 126	K	= M10x1,25	V = 10
A2	= 65	L	= M22x1,5	X = 1/8"
A3	= 137	N	= 28	
B	= 50	O	= 11	
Bore diameter	= 25	P1	= 8	
C	= 22	Stroke	= 20	
HS	= 22	T	= 17	
I	= 22	T1	= 29	